

Article number: 51836413130010

Description: Vibration damper GMF 92/45

Measures

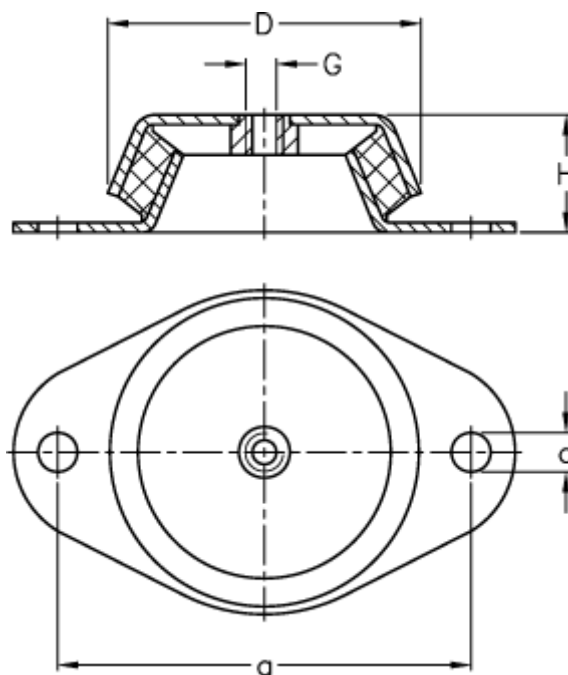

a	= 110
D	= 92
d	= 10.2
G	= M12
H	= 45
Load (daN)	= 300